

# Pressure limiter for multiple actuators

ÜB...A2  
NB...A2

**DUNGS**<sup>®</sup>  
Combustion Controls

5.07



## Technical description

The pressure limiters ÜB...A2 and NB...A2 are compact pressure switches as per EN 1854 for DUNGS multiple actuators.

The pressure switches are suitable for switching a circuit on, off or over on changes in actual pressure value relative to the set reference value. The reference valve (switching point) can be set easily and quickly by means of a setting wheel provided with a scale without the use of a pressure gauge.

## Application

Pressure switches for DUNGS multiple actuators GasMultiBloc and DMV double solenoid valve. Various mounting options directly on housing or by means of an adapter.

Standard mounting on valve housing on

the inlet side via threaded flange. Suitable for gases of families 1,2,3 and other neutral gaseous media.

## Approvals

EC type test approval as per EC Gas Appliance Directive:

ÜB A2	CE-0085 AO 3220
NB A2	CE-0085 AO 3220

EC type test approval as per EC Pressure Equipment Directive:

ÜB A2	CE0036
NB A2	CE0036

Approvals in other important gas-consuming countries. Special designs for the North American market with U<sub>L</sub>, FM and CSA registrations.

## Functional Description

Single-acting pressure limiters in the superpressure range.

The pressure limiters work without external energy supply.

### ÜB...A2, NB...A2 pressure limiters

The control unit responds to pressure. Interlock is performed when the set reference value is exceeded or undershot. The "Locked" switching state is indicated by a glow lamp.

Restart is only possible by activating the reset button on the setting wheel of the pressure limiter after the operating pressure is attained.

**ÜB...A2:** Switches on and locks if the set pressure value is exceeded.

**NB...A2:** Switches on and locks if the pressure is lower than the set pressure value.

### ÜB...A2 switching function

**As pressure rises**  
2 NO closes, 1 NC opens  
Glow lamp ON, locked.

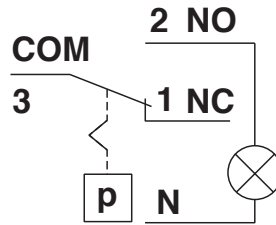

### NB...A2 switching function

**As pressure falls**  
2 NO opens, 1 NC closes  
Glow lamp ON, locked.

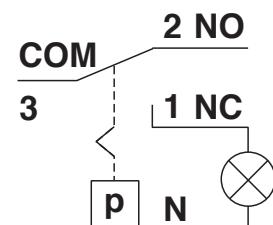

Operating state

## Specifications

Max. operating pressure	NB...A2, ÜB...A2 NB 500 A2, ÜB 500 A2	500 mbar (50 kPa) 600 mbar (60 kPa)
Pressure connection	O ring flange connection on underside of pressure switch: Gas or air	
Temperature range	Ambient temperature Medium temperature Storage temperature	-15 °C to +70 °C -15 °C to +70 °C -30 °C to +80 °C
Materials	Housing base : Hood: Switch: Diaphragms: Switching contact:	aluminium die casting polycarbonate polycarbonate NBR Standard: Ag Optional: Ag gold plated (Au), Suitable for DDC applications: 24 VDC; 0.02 A
Switching voltage	Ag contact  Au contact	AC eff. min. 10 V max. 250 V DC min. 12 V max. 48 V DC min. 5 V max. 24 V
Nominal current	Ag contact Au contact	AC eff. 10 A DC 20 mA
Switching current	Ag contact  Au contact	AC eff. min. 20 mA max. 6 A at $\cos \varphi 1$ AC eff. min. 24 mA max. 3 A at $\cos \varphi 0,6$ DC min. 20 mA max. 1 A DC min. 5 mA max. 20 mA
Electrical connection	Standard:  Special design:	plug connection for line sockets as per DIN EN 175 301-803, 3-pin with protective contact at screw terminals via cable gland, PG11
Degree of protection	IP 54 as per IEC 529 (EN 60529)	
Adjustment	In vertical installation position NB...A2: when the pressure drops ÜB...A2: when the pressure rises If the installation position is different, take the switch point change into account.	
Setting tolerance	$\pm 15\%$ switching point deviation referred to reference value	
Deviation	Permissible deviation of the set value $\leq \pm 15\%$ in the service life test according to EN 1854	

## Dimensions [mm] NB...A2, ÜB...A2

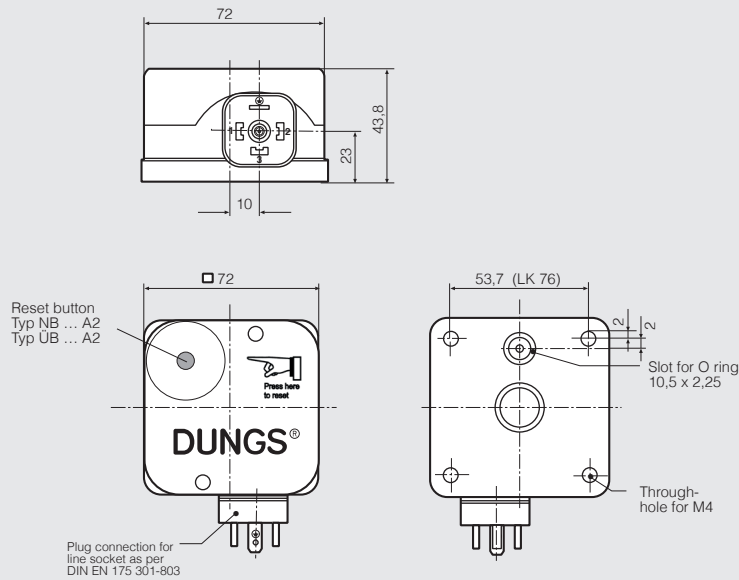

## Installation position

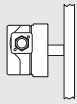

**Standard installation position**  
In case of deviations, observe the changes in switching point



**When installed horizontally, the pressure switch switches at a pressure higher by approx. 0.5 mbar**



**When installed horizontally overhead, the pressure switch switches at a pressure lower by approx. 0.5 mbar**

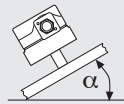

**When installed in an intermediate installation position, the pressure switch switches at pressure deviating from the set reference value by max.  $\pm 0.5$  mbar.**

## Designation

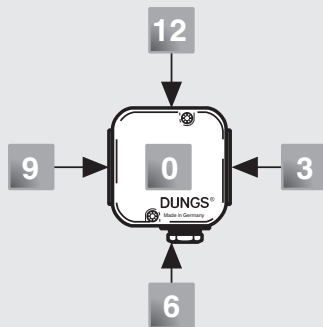

### ÜB 150 A2 [Ag-G3-V12]

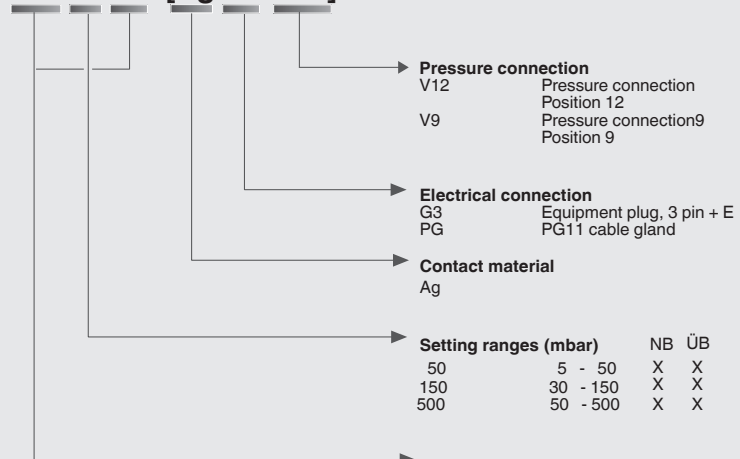

## Order example

### Pressure switch design

ÜB pressure limiter

### Setting range

30 - 150 mbar

### Contact material

Ag

### Electrical connection

Cable gland

### Pressure connection

Position 12

## ÜB 150 A2 [Ag-G3-V12]



**Pressure switch design**  
ÜB ... A2 Pressure limiter switches and locks if set reference value is exceeded.  
NB ... A2 Pressure limiter switches and locks if set reference value is undershot.

**Pressure limiter for  
multiple actuators**

**ÜB...A2  
NB...A2**

**DUNGS®**  
Combustion Controls

**Technical data**      1 mbar = 100 Pa = 0.1 kPa ≈ 10 mm WS      1 Pa = 0.01 mbar ≈ 0.1 mm WS

Type	Version Neon glow lamp ~ (AC) 230V [Ag-G3-V12]	Order No. 1 piece	Setting range [mbar]	max.	Switching difference [mbar]	Degree of pro- tection
ÜB...A2 pressure limiter	ÜB 50 A2	215 242	5 - 50	± 15 %	↑ 	IP 54
	ÜB 150 A2	215 245	30 - 150	± 15 %		IP 54
	ÜB 500 A2	215 246	50 - 500	± 15 %		IP 54
	<b>[Ag-G3-V12]</b>	<b>1 piece</b>	<b>[mbar]</b>	<b>max.</b>	<b>[mbar]</b>	
NB...A2 pressure limiter	NB 50 A2	215 237	5 - 50	± 15 %	↓ 	IP 54
	NB 150 A2	215 240	30 - 150	± 15 %		IP 54
	NB 500 A2	215 241	50 - 500	± 15 %		IP 54

Accessories for pressure switch NB...A2, ÜB...A2	Order-No.
Glow lamp yellow, (1 x) ~(AC) 230 V (Spare part NB, ÜB)	266 039
Glow lamp yellow, (1 x) ~(AC) 120 V (Spare part NB, ÜB)	244 156
Signal lamp LED yellow, 24 V AC/DC (1 x)	244 157
Line sockets, 3-pin + E, grey GDMW	210 318

Adapter	Order No..	For Equipment / type	Nominal diameters
Mounting kit	223 280	MB-..., DMV-...	Rp 3/8 - DN 125
Adapter p <sub>Br</sub>	273 777	MB-D... 405-420 MB-Z... 405-420 DMV-... 503-520/11	Rp 3/8 - Rp 2 Rp 3/8 - Rp 2 Rp 3/8 - Rp 2
Adapter on threaded flange G 1/8	221 630	MB-... 405-412 DMV-...	Rp 3/8 - Rp 1 1/4 Rp 3/8 - Rp 2
Adapter kit for GW ... A2 with G 1/4 connection	222 982	MB-... 415,420 DMV	Rp 1 - Rp 2 Rp 3/8 - Rp 2

We reserve the right to make any changes in the interest of technical progress.

**Head Offices and Factory**  
Karl Dungs GmbH & Co. KG  
Karl-Dungs-Platz 1  
D-73660 Urbach, Germany  
Telephone +49 (0)7181-804-0  
Telefax +49 (0)7181-804-166

**Postal address**  
Karl Dungs GmbH & Co. KG  
Postfach 12 29  
D-73602 Schorndorf, Germany  
e-mail info@dungs.com  
Internet www.dungs.com